

# Fiber-Fiber™ Optical Switch

## 1x1, Dual 1x1, 1x2

(SM, PM, MM, Broadband, Bidirectional, <0.5ms Fast Switching)



DATASHEET

[Return to the Webpage](#)



### Features

- Ultra Low Loss ~0.2dB
- Ultra Broadband
- Little Wavelength Dependence
- Little Temperature Dependence
- Fast <0.5ms
- Vibration Insensitive

### Applications

- Laser Systems
- Reconfigurable Optics
- Instrumentations

The FF Series fiber optic switch delivers industry-leading performance, offering nearly lossless, continuous light transmission without perturbations. Its ultra-broadband operation is limited only by the intrinsic properties of the fiber, making it highly versatile for a wide range of applications. The switch features fast switching times (<1 ms), insensitivity to temperature and vibration, a high on/off extinction ratio, high polarization extinction ratio, and cost-effective. At the core of this innovative design is a MEMS-based auto-alignment silicon chip, which achieves direct fiber-to-fiber coupling. A tiny gap (less than 5 microns) between fibers is filled with a non-fluorescent, index-matching liquid, creating an ultra-low-loss optical path without requiring lenses or coatings—effectively eliminating surface reflection issues. This design ensures continuous, high-fidelity light transmission, making it ideal for spectroscopy, optical coherence tomography (OCT), interferometry, and other systems sensitive to optical losses and reflections. The FF platform is compatible with all fiber types that have a 125 μm outer diameter, including single-mode (SM), multimode (MM), polarization-maintaining (PM), double-cladding fibers, and bend-insensitive fibers, supporting both large and small core configurations. The switch operates via an electrical relay with a latching mechanism, maintaining the selected optical path even when power is removed. Bidirectional light paths are controlled using a 4.5V electrical pulse, with no continuous power consumption required—energy is only consumed during switching events. Two versions of MEMS chips are available: a fast-switching chip optimized for single-mode fibers and a slow-switching chip designed for polarization-maintaining fibers. The PM fiber switches maintain both polarization states consistent with the input fiber's alignment.

### Specifications

Parameter	Min	Typical	Max	Unit
Wavelength	350		5500	nm
Insertion Loss <sup>[1]</sup>	0.01	0.2	0.4	dB
Wavelength Dependent Loss			0.01	dB
Polarization Dependent Loss			0.05	dB
Polarization Extinction Ratio (PM)	23	25	35	dB
Return Loss	50 (SM)			dB
	35 (MM) <sup>[3]</sup>			dB
Cross Talk On/Off Ratio	50		75	dB
Optical Rise/Fall Time (PM Fiber) <sup>[2]</sup>	5		20	ms
Optical Rise/Fall Time (SM Fiber) <sup>[2]</sup>	0.2	0.4	0.8	ms
Repetition Rate (PM Fiber)			1	Hz
Repetition Rate (SM Fiber)			5	Hz
Repeatability			± 0.02	dB
Durability	10 <sup>8</sup>			cycles
Operating Optical Power <sup>[3]</sup>		0.3	2	W
Operating Voltage	4.3		4.5	VDC
Operating Current		30	60	mA
Switching Type	Latching / Non-Latching			
Operating Temperature	-40		80	°C
Storage Temperature	-50		90	°C

#### Notes:

[1]. SM 28 Fiber, Typical loss is 0.3dB. Ultra-low loss 0.1 is special order. Excluding Connectors. For small core fibers the specs are reduced. For IR fluoride fiber loss increase.

[2]. Rise/Fall time is defined as 10/90% optical signal change.

[3]. For 1310/1550nm. The optical power handling rapidly reduces as fiber core size/ reduces. At 650nm the max is 2mW. Expanding the fiber core can increase the power handling. We tested 105/125 fiber to safely handle 2W CW optical power.

**Legal notices:** All product information is believed to be accurate and is subject to change without notice. Information contained herein shall legally bind Agiltron only if it is specifically incorporated into the terms and conditions of a sales agreement. Some specific combinations of options may not be available. The user assumes all risks and liability whatsoever in connection with the use of a product or its application.

Rev 03/13/25

# Fiber-Fiber™ Optical Switch

## 1x1, Dual 1x1, 1x2



(SM, PM, MM, Broadband, Bidirectional, <0.5ms Fast Switching)

### DATASHEET

#### Mechanical Dimensions For PM Fiber (square shape with slow MEMS,) (Unit: mm)

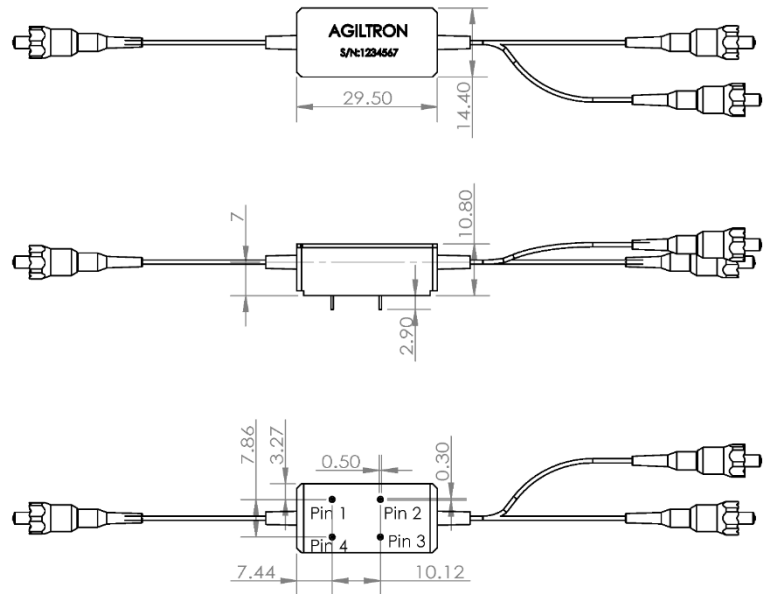

B

#### Mechanical Dimensions For SM Fiber (T-shape with Fast MEMS,) (Unit: mm)

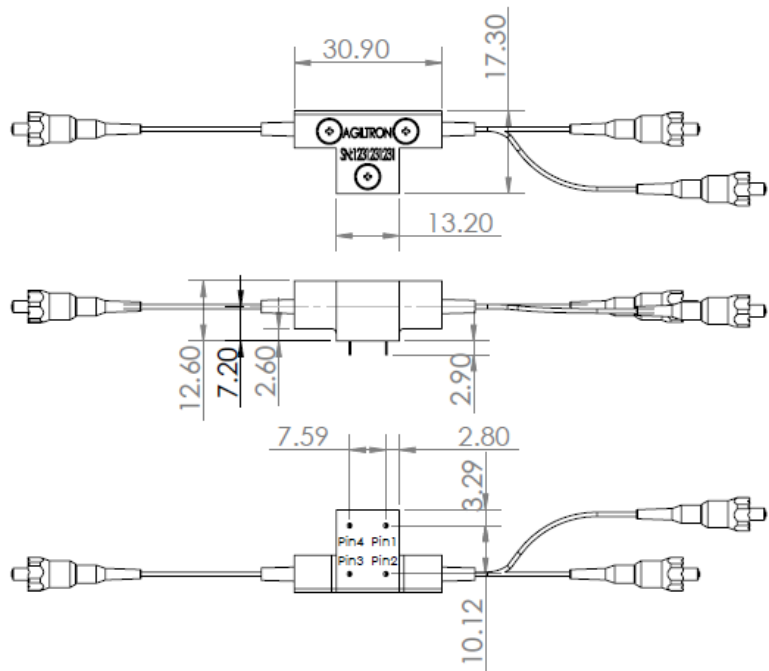

A

\*Product dimensions may change without notice. This is sometimes required for non-standard specifications.

# Fiber-Fiber™ Optical Switch 1x1, Dual 1x1, 1x2



(SM, PM, MM, Broadband, Bidirectional, <0.5ms Fast Switching)

## DATASHEET

### Typical Response Speed (SM, Package S)

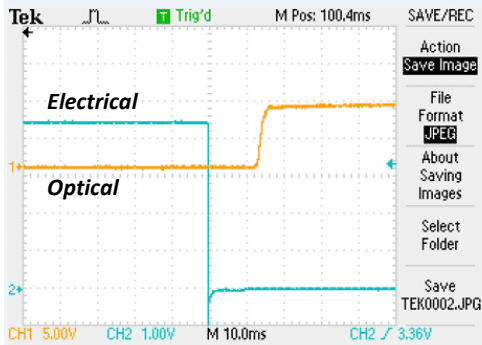

Channel 1 Optical Rise and Fall

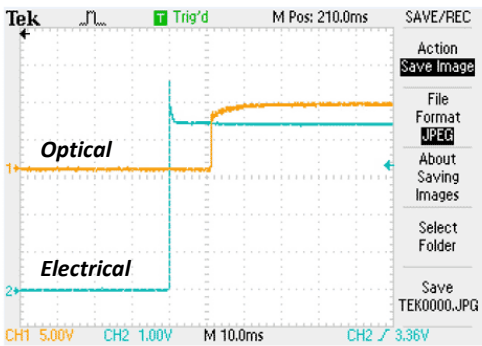
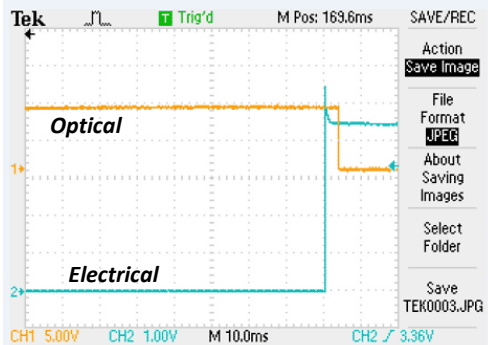

Channel 2 Optical Rise and Fall

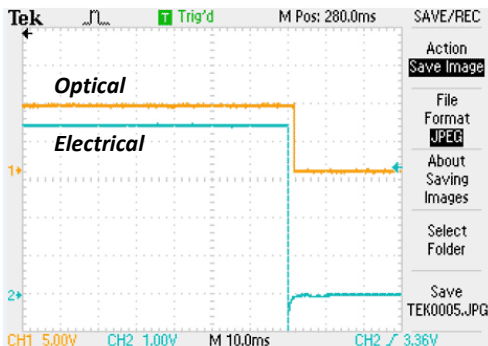

### Optical Response Speed (SM Package F)

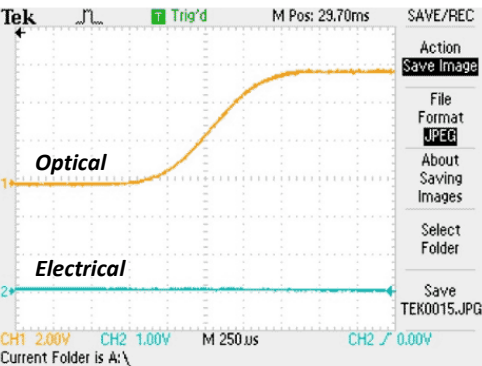

Channel 1 Optical Rise and Fall

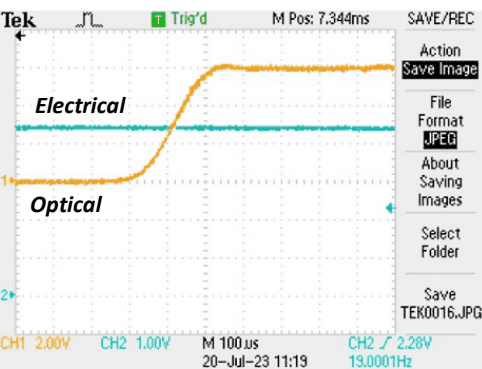
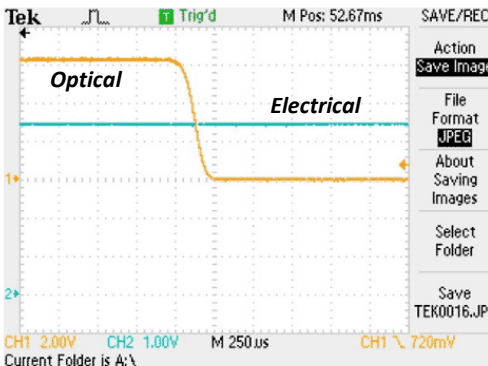

Channel 2 Optical Rise and Fall

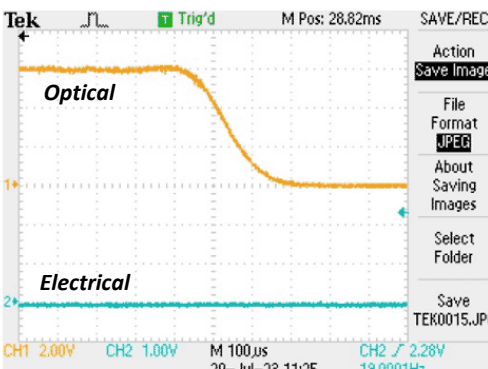

# Fiber-Fiber™ Optical Switch

## 1x1, Dual 1x1, 1x2



(SM, PM, MM, Broadband, Bidirectional, <0.5ms Fast Switching)

### DATASHEET

#### Typical Response Speed (SM Package F )

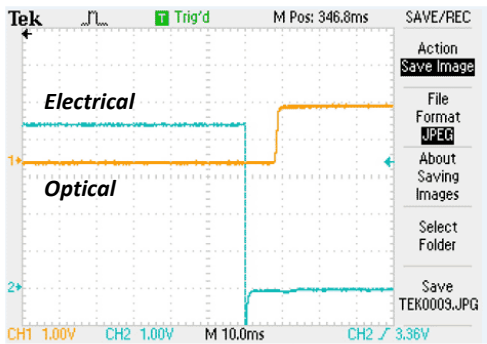

Channel 1 Optical Rise and Fall

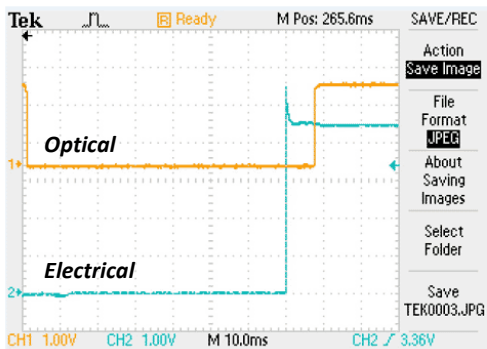
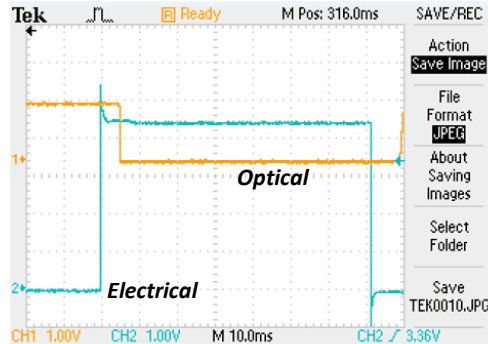

Channel 2 Optical Rise and Fall

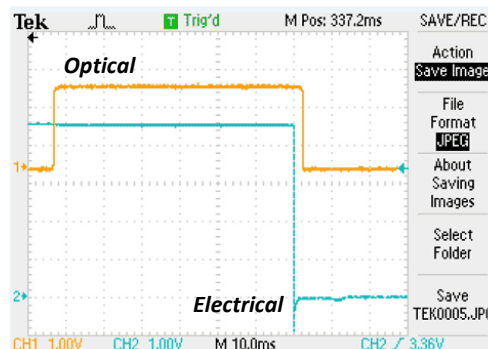

#### Electrical Connector Configurations

Important Note: The device must be driven by the reference circuit. Otherwise, it is not stable. This is because the device contains a permanent magnet inside; thus current must flow in the correct direction to counter the magnet field.

The load is a resistive coil which is activated by applying 4.5V (draw ~ 40mA). The latching switches can also be driven by a pulse mode for energy saving. The switch can withstand 5V which may reduces its durability.

Agiltron offers a computer control kit with TTL and USB interfaces and Windows™ GUI. We also offer RS232 interface as an option.

#### Latching Type

The activation requires a 4.5V pulse with a duration >15ms

Optical Path	Electric Drive	
	Pin 2	Pin 3
Port 1 → Port 2	4.5V	0V
Port 1 → Port 3	0V	4.5V

#### Non-Latching Type

Optical Path	Electric Drive	
	Pin 2	Pin 3
Port 1 → Port 2	0V	0V
Port 1 → Port 3	0V	4.5V

# Fiber-Fiber™ Optical Switch

## 1x1, Dual 1x1, 1x2



(SM, PM, MM, Broadband, Bidirectional, <0.5ms Fast Switching)

### DATASHEET

#### Functional Diagram

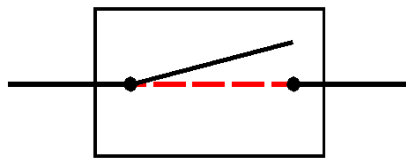

1x1 Switch

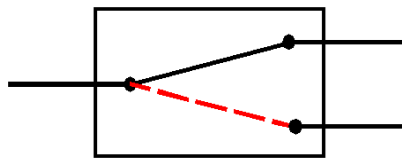

1x2 Switch

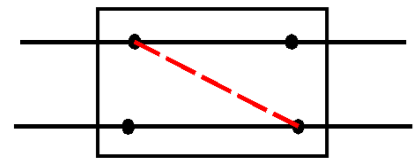

2x2 Bypass Switch

#### Optical Power Handling vs Wavelength for Standard SM Fibers

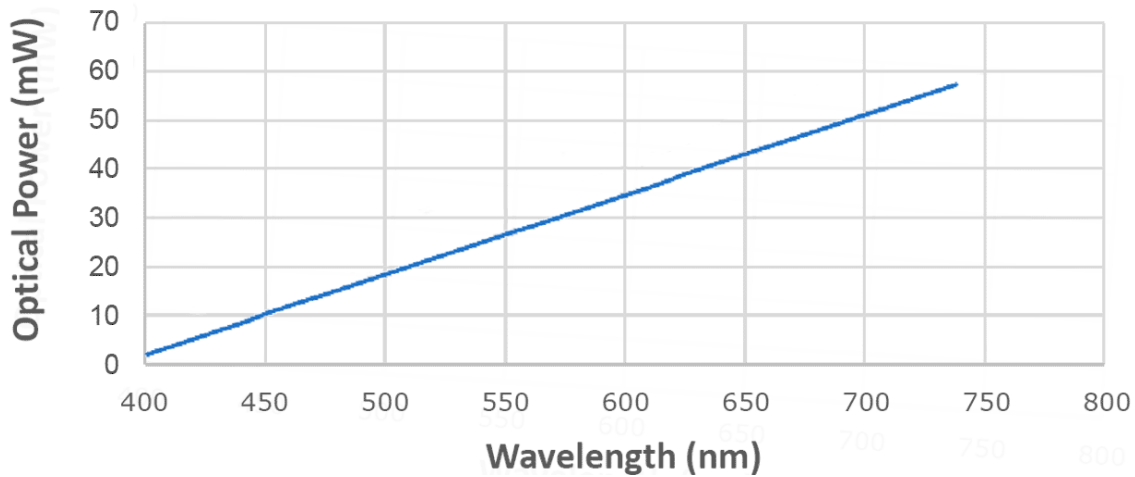

# Fiber-Fiber™ Optical Switch 1x1, Dual 1x1, 1x2



(SM, PM, MM, Broadband, Bidirectional, <0.5ms Fast Switching)

## DATASHEET

### Ordering Information

Prefix	Type	Package	Test Wavelength <sup>[4]</sup>	Fiber Type	Fiber Cover	Fiber Length	Connector	Driver
<b>FFSW-</b>	1x1 (Transparent) <sup>[1]</sup> = 11 1x1 (Opaque) = 1D 1x1 (Ultralow Loss) = U1 1x2 Standard = 12 1x2 (Ultralow Loss) = U2 High Power 1x2 <sup>[2]</sup> = H2 High Power 1x1 = H1	Latching = L Non-Latching = N  A Latching = 2 A Non-latching = 3 B Latching = 6 B Non-latching = 7	488 nm = 4 360 nm = A 430 nm = B 532 nm = 5 630 nm = 6 780 nm = 7 850 nm = 8 980 nm = 9 1060 nm = 1 1310 nm = 3 1550 nm = C 2000 nm = 2 2.3-4.1 μm = F 3.2-5.5 μm = G	<i>Pick from below table to match the wavelength range</i>	Bare fiber = 1 900um tube = 3 Special = 0	0.25m = 1 0.5m = 2 1.0m = 3 Special = 0	None = 1 FC/PC = 2 FC/APC = 3 SC/PC = 4 SC/APC = 5 ST/PC = 6 LC/PC = 7 Duplex LC/PC = 8 MTP = 9 LC/APC = A LC/UPC = U Special = 0	Non = 1 USB = 2 RS232 = 3 TTL = 4

[1] Transparent: Light passes through without activation. Opaque: Light is blocked in the non-activated state.

[2] The beam size expands approximately 5x within the fiber tip.

[3] Fast latching is available for PM fiber at twice the cost of slow latching.

[4] This ultra-broadband device is limited by the intrinsic transmission of the fiber and is tested at a single selected wavelength. Testing at multiple wavelengths is available under the "special = 0" option at an additional cost, though it may be unnecessary, as fiber transmission data can be referenced directly from the fiber specifications.

Red: old part numbers

**Fiber Type Selection Table:**

01	SMF-28	34	PM1550	71	MM 50/125μm
02	SMF-28e	35	PM1950	72	MM 62.5μm
03	Corning XB	36	PM1310	73	105/125μm
04	SM450	37	PM400	74	FG105LCA
05	SM1950	38	PM480	75	FG50LGA
06	SM600	39	PM630	76	STP 50/125
07	780HP	40	PM850	77	IRZS23
08	SM800	41	PM980	78	IRZS32
09	SM980	42	PM780	79	
10	Hi1060	43		80	
11	SM400	44	PM405	81	UV180nm
12		45	PM460		
13		46			

### Typical Fiber Transmissions

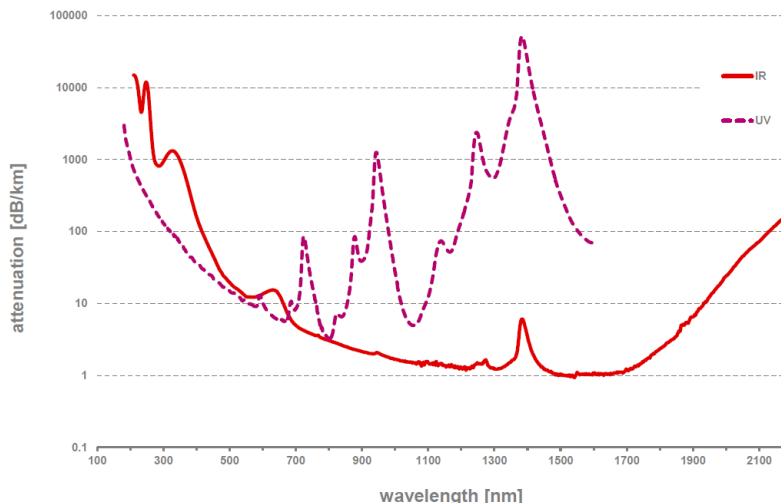

# Fiber-Fiber™ Optical Switch

## 1x1, Dual 1x1, 1x2



(SM, PM, MM, Broadband, Bidirectional, <0.5ms Fast Switching)

### DATASHEET

#### Driver Reference Design

